

3.0 GHz DIVIDE BY 2 PRESCALER

FEATURES

- **HIGH FREQUENCY OPERATION TO 3 GHz**
- **FIXED DIVIDE RATIO: $\div 2$**
- **LOW CURRENT CONSUMPTION: 12 mA at 5 V**
- **SMALL PACKAGE: 8 pin SSOP**
- **AVAILABLE IN TAPE AND REEL**

INTERNAL BLOCK DIAGRAM

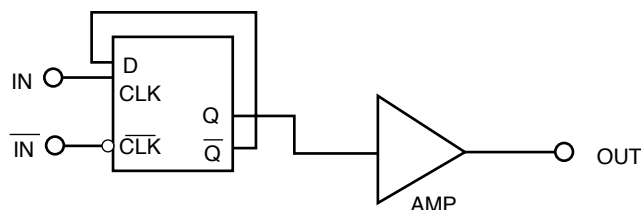

DESCRIPTION

The UPB1508GV is a Silicon RFIC digital prescaler manufactured with the NESAT™ IV silicon bipolar process. It features frequency response to 3 GHz, a divide-by-two ratio, and operates on a 5 volt supply while drawing only 12 mA. The device is housed in a small 8 pin SSOP package that contributes to system miniaturization. The low power consumption and wide frequency operation makes the device well suited for use in a PLL synthesizer for UHF/VHF TV and DBS tuner applications.

ELECTRICAL CHARACTERISTICS ($T_A = -40$ to $+85^\circ\text{C}$, $V_{CC} = 4.5$ to 5.5 V, $Z_s = Z_L = 50 \Omega$)

PART NUMBER PACKAGE OUTLINE			UPB1508GV S08		
SYMBOLS	PARAMETERS AND CONDITIONS	UNITS	MIN	TYP	MAX
I_{CC}	Supply Current	mA	7.6	12	14.5
$f_{IN (U)}$	Upper Limit Operating Frequency, $P_{IN} = -10$ to $+6$ dBm $P_{IN} = -15$ to $+6$ dBm	GHz GHz	3.0 2.7		
$f_{IN (L)}$	Lower Limit Operating Frequency, $P_{IN} = -15$ to $+6$ dBm	GHz			0.5
P_{IN}	Input Power, $f_{IN} = 2.7$ to 3.0 GHz $f_{IN} = 0.5$ to 2.7 GHz	dBm dBm	-10 -15		+6 +6
P_{OUT}	Output Power, $P_{IN} = 0$ dBm, $f_{IN} = 2$ GHz	dBm	-12	-7	

ABSOLUTE MAXIMUM RATINGS¹ (T_A = 25°C)

SYMBOLS	PARAMETERS	UNITS	RATINGS
V _{CC}	Supply Voltage	V	6.0
V _{IN}	Input Voltage	V	6.0
P _T	Total Power Dissipation ²	mW	250
T _{OP}	Operating Temperature	°C	-40 to +85
T _{STG}	Storage Temperature	°C	-55 to +150

Notes:

1. Operation in excess of any one of these parameters may result in permanent damage.
2. Mounted on a double-sided copper clad 50x50x1.6 mm epoxy glass PWB (T_A = +85°C).

RECOMMENDED OPERATING CONDITIONS

SYMBOL	PARAMETER	UNITS	MIN	TYP	MAX
V _{CC}	Supply Voltage	V	4.5	5.0	5.5
T _{OP}	Operating Temperature	°C	-40	+25	+85

TEST CIRCUIT

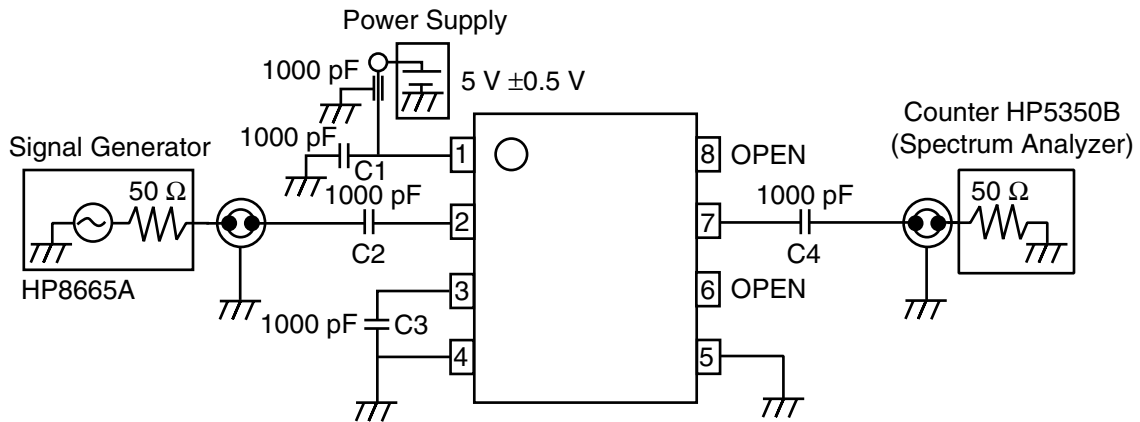

PIN DESCRIPTIONS

Pin no.	Symbol	Applied Voltage	Pin Voltage	Description
1	V _{CC}	4.5 to 5.5		Power supply pin. This pin must be equipped with bypass capacitor (eg 1000 pF) to ground.
2	IN		1.7 to 4.95	Signal input pin. This pin should be coupled with a capacitor (eg 1000 pF).
3	$\overline{\text{IN}}$		1.7 to 4.95	Signal input bypass pin. This pin must be equipped with a bypass capacitor (eg 1000 pF) to ground.
4, 5	GND	0		Ground pin. Ground pattern on the board should be formed as wide as possible to minimize ground impedance.
6	NC			No connection. This pin should be left open.
7	OUT		1.0 to 4.7	Divided frequency output pin. This pin should be coupled to load device with a capacitor (eg 1000 pF).
8	NC			No connection. This pin should be left open.

TYPICAL PERFORMANCE CURVES (Unless otherwise specified, $T_A = 25^\circ\text{C}$)

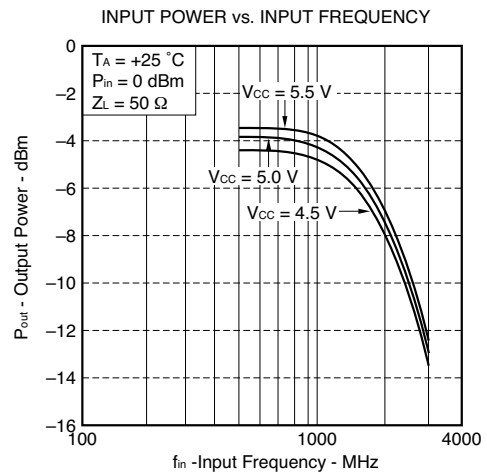
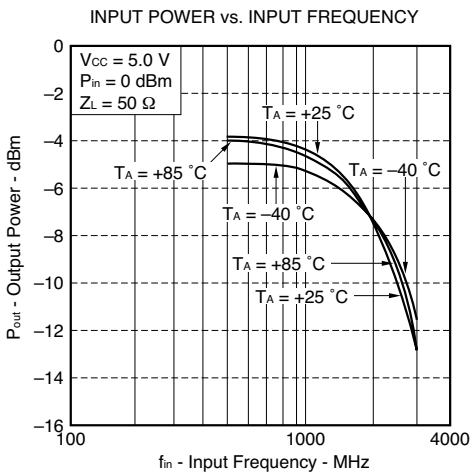
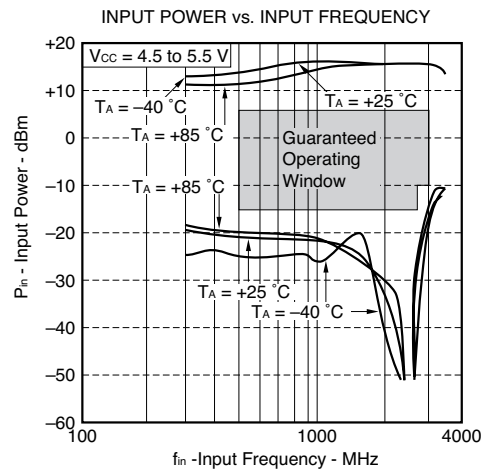
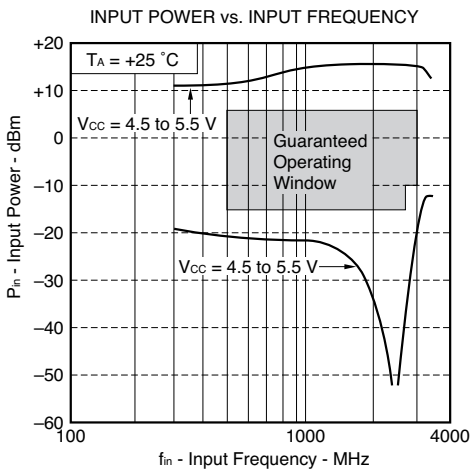
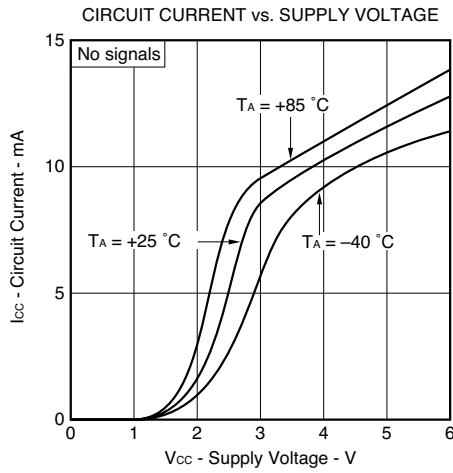

TYPICAL PERFORMANCE CURVES (Unless otherwise specified, $T_A = 25\text{ }^\circ\text{C}$)

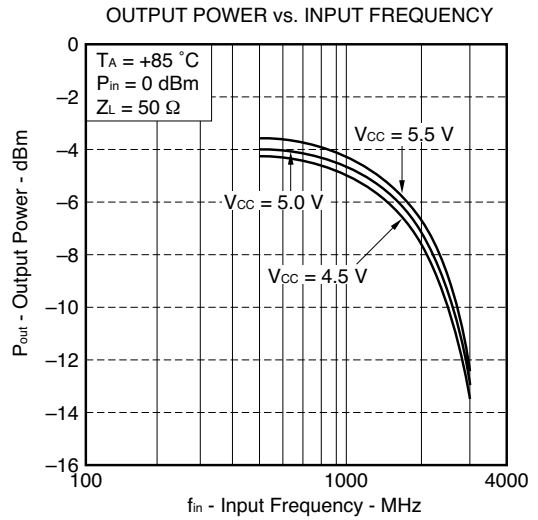
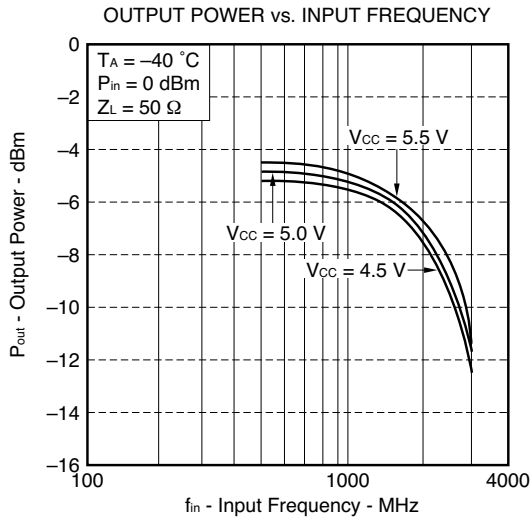

TYPICAL SCATTERING PARAMETERS ($T_A = 25\text{ }^\circ\text{C}$)

S11 vs. INPUT FREQUENCY
 $V_{CC} = 5.0\text{ V}$

S11 Z
 REF 1.0 Units
 2 200.0 mUnits/
 ▽ 34.604 Ω -26.496 Ω

hp

C

D

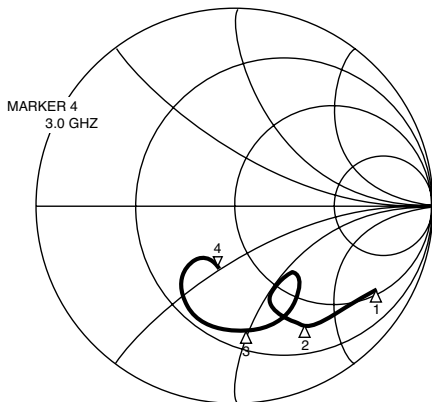

START 0.500000000 GHz
 STOP 3.000000000 GHz

- Δ_1 : 0.5 GHz
- Δ_2 : 1.0 GHz
- Δ_3 : 2.0 GHz
- Δ_4 : 3.0 GHz

FREQUENCY		S11	
GHz	ANG	MAG	
0.5		0.850	-30.2
0.6		0.796	-37.8
0.7		0.790	-39.2
0.8		0.754	-45.2
0.9		0.766	-53.7
1.0		0.701	-57.6
1.1		0.660	-62.3
1.2		0.606	-67.2
1.3		0.571	-70.3
1.4		0.521	-70.6
1.5		0.495	-68.3
1.6		0.441	-60.6
1.7		0.479	-45.1
1.8		0.602	-62.3
1.9		0.595	-74.2
2.0		0.608	-82.9
2.1		0.603	-89.8
2.2		0.599	-97.3
2.3		0.588	-107.7
2.4		0.532	-122.0
2.5		0.396	-132.0
2.6		0.325	-127.1
2.7		0.270	-123.6
2.8		0.232	-122.7
2.9		0.258	-105.8
3.0		0.351	-103.7

TYPICAL SCATTERING PARAMETERS (TA = 25 °C)

S22 vs. OUTPUT FREQUENCY

Vcc = 5.0 V, fin = 498 MHz

S22 Z
 REF 1.0 Units
 2 200.0 mUnits/
 ▽ 87.789 Ω -13.633 Ω
 hp

C
 D

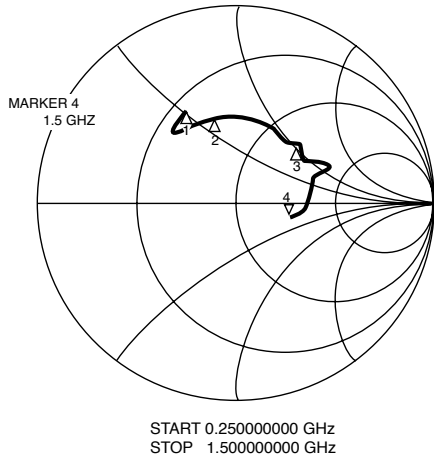

FREQUENCY		S22	
GHz	ANG	MAG	
0.25		0.526	118.9
0.30		0.463	131.2
0.35		0.466	124.7
0.40		0.460	117.1
0.45		0.441	110.2
0.50		0.456	103.0
0.55		0.353	94.8
0.60		0.438	91.1
0.65		0.444	83.9
0.70		0.436	78.3
0.75		0.435	71.8
0.80		0.431	65.9
0.85		0.431	60.3
0.90		0.431	53.7
0.95		0.408	49.2
1.00		0.445	44.9
1.05		0.428	41.0
1.10		0.429	33.7
1.15		0.355	42.7
1.20		0.418	20.0
1.25		0.403	17.1
1.30		0.392	9.6
1.35		0.368	3.3
1.40		0.343	-3.4
1.45		0.319	-9.2
1.50		0.289-	14.1

S22 vs. OUTPUT FREQUENCY

Vcc = 5.0 V, fin = 3002 MHz

S22 Z
 REF 1.0 Units
 2 200.0 mUnits/
 ▽ 91.109 Ω 2.6523 Ω
 hp

C
 D

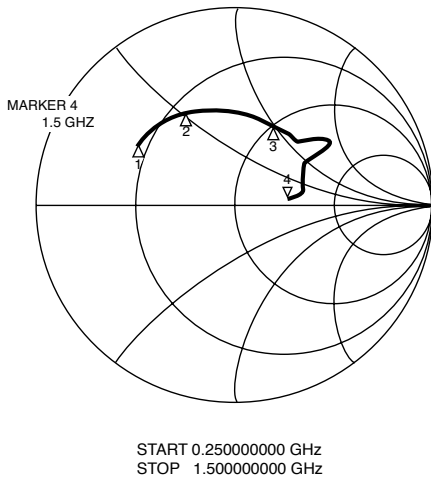

FREQUENCY		S22	
GHz	ANG	MAG	
0.25		0.555	146.6
0.30		0.545	139.9
0.35		0.571	136.1
0.40		0.529	127.9
0.45		0.521	122.4
0.50		0.515	116.9
0.55		0.510	104.5
0.60		0.492	106.6
0.65		0.487	100.9
0.70		0.482	95.3
0.75		0.473	89.9
0.80		0.461	83.8
0.85		0.454	78.4
0.90		0.449	72.3
0.95		0.430	69.6
1.00		0.443	64.3
1.10		0.440	52.3
1.15		0.438	46.0
1.20		0.501	37.5
1.25		0.408	32.9
1.30		0.388	25.1
1.35		0.359	16.3
1.40		0.335	9.7
1.45		0.304	3.1
1.50		0.285	4.6

SYSTEM APPLICATION EXAMPLE

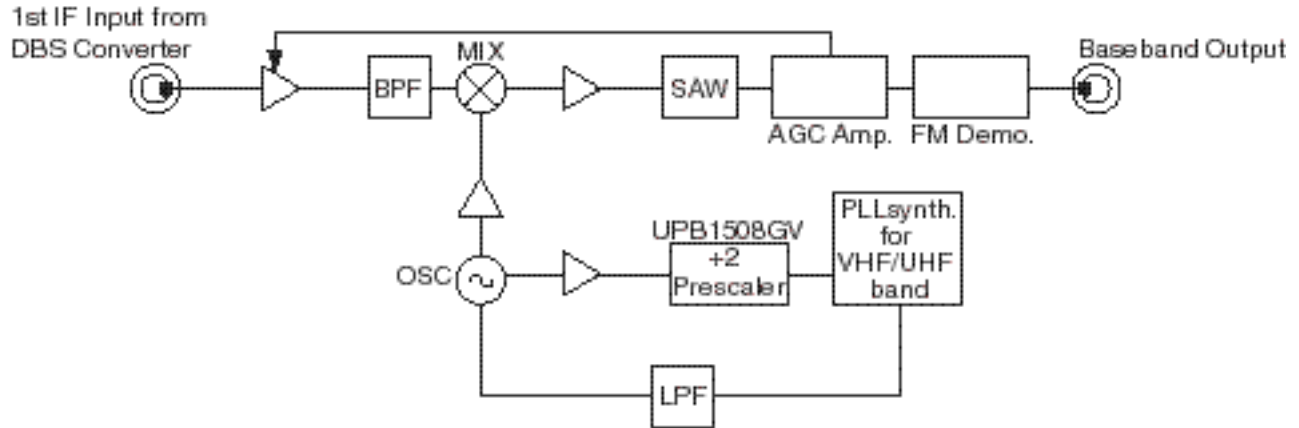

OUTLINE DIMENSIONS (Units in mm)

PIN CONNECTION

PACKAGE OUTLINE S08

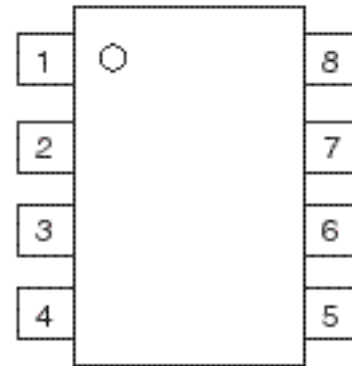
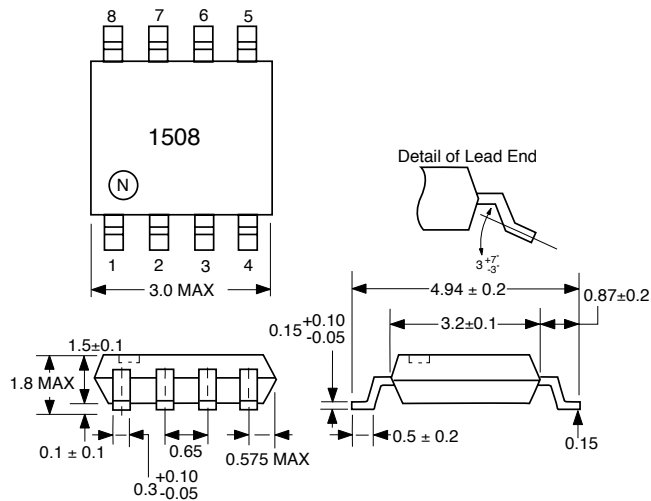

PIN CONNECTIONS

- 1. Vcc
- 2. IN
- 3. $\bar{I}N$
- 4. GND
- 5. GND
- 6. NC
- 7. OUT
- 8. NC

ORDERING INFORMATION

PART NUMBER	QUANTITY
UPB1508GV-E1-A	1000/Reel

Note:

- 1. Embossed tape 8 mm wide.
Pin 1 is in the tape pull-out direction.

EXCLUSIVE NORTH AMERICAN AGENT FOR RF, MICROWAVE & OPTOELECTRONIC SEMICONDUCTORS

CEL CALIFORNIA EASTERN LABORATORIES • Headquarters • 4590 Patrick Henry Drive • Santa Clara, CA 95054-1817 • (408) 919-2500 • Telex 34-6393 • FAX (408) 988-0279
24-Hour Fax-On-Demand: 800-390-3232 (U.S. and Canada only) • Internet: <http://WWW.CEL.COM>

DATA SUBJECT TO CHANGE WITHOUT NOTICE

03/31/2009